**STRUCTURAL CONTROL OF HIGH RISE BUILDING USING
A TUNED MASS WITH INTEGRAL HERMETICALLY
SEALED, FRICTIONLESS HYDRAULIC DAMPERS**

by

**Alan Klembczyk, Chief Engineer
Taylor Devices, Inc.
90 Taylor Drive
North Tonawanda, NY 14120-0748**

**Brian Breukelman, Technical Director - Damping Systems
Rowan Williams Davies & Irwin Inc.
Guelph, Ontario, Canada N1K 1B8**

**STRUCTURAL CONTROL OF HIGH RISE BUILDING USING A TUNED
MASS WITH INTEGRAL HERMETICALLY SEALED,
FRICTIONLESS HYDRAULIC DAMPERS**

Alan Klembczyk, Chief Engineer
Taylor Devices, Inc.
North Tonawanda, NY 14120-0748
716-694-0800

Brian Breukelman, Technical Director - Damping Systems
Rowan Williams Davies & Irwin Inc.
Guelph, Ontario, Canada N1K 1B8
519-823-1311

Structural control of large buildings using tuned mass damper systems has gained wide acceptance in North America in recent years. Significant structural performance improvements during wind storms have been realized using both active and passive systems. Disadvantages of employing the use of active systems include high engineering and implementation costs, high maintenance costs, unnecessary system complexities, and the requirement for a continuous and non-interrupted power supply. A design for a passive tuned mass damper system is presented with analytical simulations and component test results. These demonstrate the effectiveness of using a tuned mass in conjunction with a maintenance free, hydraulic damper, having frictionless flexural seals to successfully attenuate the response of a high rise building subject to severe wind inputs.

INTRODUCTION

Tuned mass damper (TMD) systems have been incorporated into many structures and dynamic systems throughout the world to effectively increase the level of damping within the structure itself and thereby reduce undesirable oscillations. Typical applications include tall and narrow structures that generally produce high resulting amplitudes due to the ease at which the structure can be excited in its primary mode. The first mode natural frequency of tall buildings that may require additional damping are typically in the range of 1 Hz or below. However, TMD's have also been incorporated into other mechanical components that are being driven at or near their natural frequency either by an internal or external source. TMD's for these types of applications have been used to effectively attenuate first mode responses in the range of up to 25 Hz or more.

A detailed wind engineering investigation for the Park Tower, a 67 storey condominium/hotel building recently constructed in Chicago, was performed by RWDI to determine the wind-induced bending moments and shear forces, the curtain wall design pressures, the local pedestrian wind environment and the wind induced accelerations of the top occupied floors. As a structure becomes taller, lighter or more slender, the possibility of excessive accelerations of the upper floors during relatively common wind events becomes more likely. Building occupants tend to become sensitized to building motions, especially if the tenancy of the building is residential.

After initial investigations indicated that the peak acceleration of the upper floors of the Park Tower would have exceeded the maximum target value, a solution was proposed that included incorporating a TMD near the top of the building. This TMD would essentially consist of a mass of 300 tons suspended by pendulum cables and would include the use of hermetically sealed, frictionless hydraulic dampers.

ACCELERATION CRITERIA

Acceptability criteria for accelerations are not currently codified in North America. However, general guidelines do exist that are generally accepted by the wind engineering community. Figure 1 proposes a guideline for the peak 5 year return period acceleration as a function of building period. The National Building Code of Canada (NBCC) “recommends” a range of accelerations of 10 to 30 milli-g (1000th of acceleration due to gravity) for the 10 year return period. There is no indication in the NBCC criteria whether the recommendations are for residential or commercial building occupancy. In addition, the International Organization for Standardization (ISO) has recommended for commercial (or office) occupancies 1 and 5 year return period criteria that depend on the natural period of the building. For a building like the Park Tower, with a period of about 5 seconds, this translates into acceleration criteria of approximately 12 milli-g (1.2% of gravity) for the 1 year return period and 18 milli-g for the 5 year return period. Factoring the ISO criterion to account for the residential occupancy and extrapolating the 5 year return period to the 10 year return period, a generally accepted criterion of 15 milli-g (1.5%) of gravity is produced.

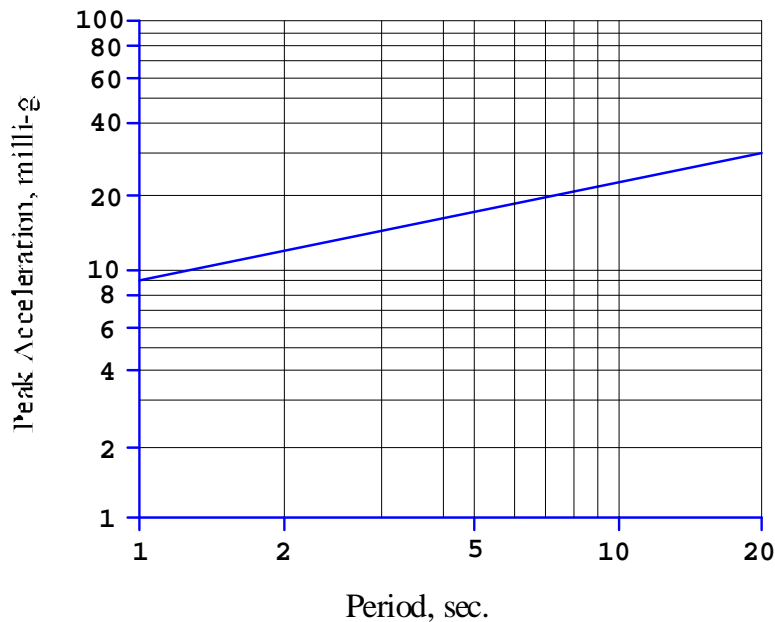

FIGURE 1 – GUIDELINE FOR 5 YEAR ACCELERATION IN BUILDINGS

WIND ENGINEERING ANALYSIS

To determine structural wind loads and wind-induced accelerations, a scaled model of the building as shown in Figure 2, is placed in the wind tunnel and tested for 36 azimuthal wind directions. The immediate surroundings of the building are modeled accurately, while the upwind fetches are modeled to generate the appropriate wind profile. For example, winds approaching the building over the waters of Lake Michigan are modeled as an ASCE profile “C”, while winds approaching the building from the west are modeled as ASCE profile “B.” In the wind tunnel, allowances can be made for additional roughness where an upwind profile might be somewhere between an ASCE profile “B” and “A.” A High-Frequency Force-Balance (HFFB) test was performed where the bending moments and shears are measured directly from the model to give generalized wind forces. These are then combined with structural characteristics, such as building mass, mode shapes and an estimate of the structural damping to determine the full scale dynamic behavior of the building. Additional wind tunnel testing using an aeroelastic wind tunnel model was performed to obtain more accurate predictions of the building accelerations. Aeroelastic wind tunnel testing allows one to measure the dynamic response directly from the model and will account for the usually beneficial effect of aerodynamic damping as well as a more accurate characterization of the peak responses.



FIGURE 2 – MODEL OF THE PARK TOWER IN RWDI'S WIND TUNNEL

Figure 3 shows a particular result of such a wind tunnel test for the Park Tower. The wind-induced bending moment in one of the building's principal axes, that include the mean value, background and resonant components are plotted versus 36 azimuthal wind directions. It is interesting to note that there is a range of wind directions from approximately 10° and 40° (as measured from North) where the wind-induced bending moments are much larger than those for the remaining wind directions. Further investigations into these wind directions revealed that upwind buildings were having a significant impact on the wind-induced responses of the building, as these higher bending moments are indicative of higher accelerations as well. Figure 3 also shows the results of the aeroelastic wind tunnel testing, that for most wind directions indicated reduced bending moments and correspondingly lower accelerations. The final predicted accelerations for the Park Tower were in the range of 20 to 23 milli-g, which was higher than the desired criterion of 15 milli-g.

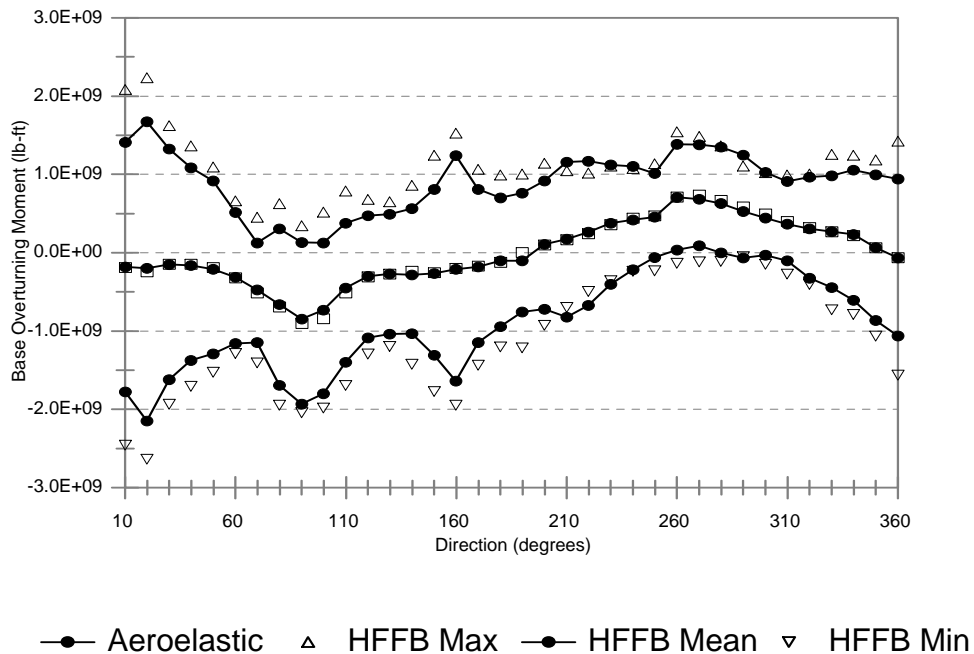

FIGURE 3 – WIND-INDUCED BENDING MOMENTS

In an effort to reduce the wind induced moments and accelerations, the structural engineers investigated a number of possible structural solutions. Additional mass was added by thickening all of the floor slabs while additional stiffness was provided by deepening the spandrel beams. All of these structural measures reduced the resonant effects, but they were not sufficient to reduce the accelerations to an acceptable level. Any additional structural modifications would have impacted the architecture of the Park Tower and further work on structural modifications were abandoned in favor of investigating supplementing the structural damping of the building.

DAMPING SYSTEM CONCEPT

A number of damping systems were investigated during a concept design phase. A Tuned Mass Damper (TMD) was selected as space was available for such a device in the mechanical levels at the top of the tower, and also the proposed concept was a simple device with no maintenance requirements, other than routine inspection.

Den Hartog [1] and others have developed the background theory for a TMD to produce simple expressions predicting the behavior of a structure with a supplemental moving mass attached. Using these simple expressions, it is possible to predict the effective damping of a structure with a TMD installed. This effective damping is a combination of the original structural damping and the damping provided by the TMD. These predictions can be made as a function of the size of the added mass as a ratio of the generalized mass of the building and the frequency or tuning ratio. The effective damping that can be provided using a TMD for a number of mass ratios is given in Figure 4.

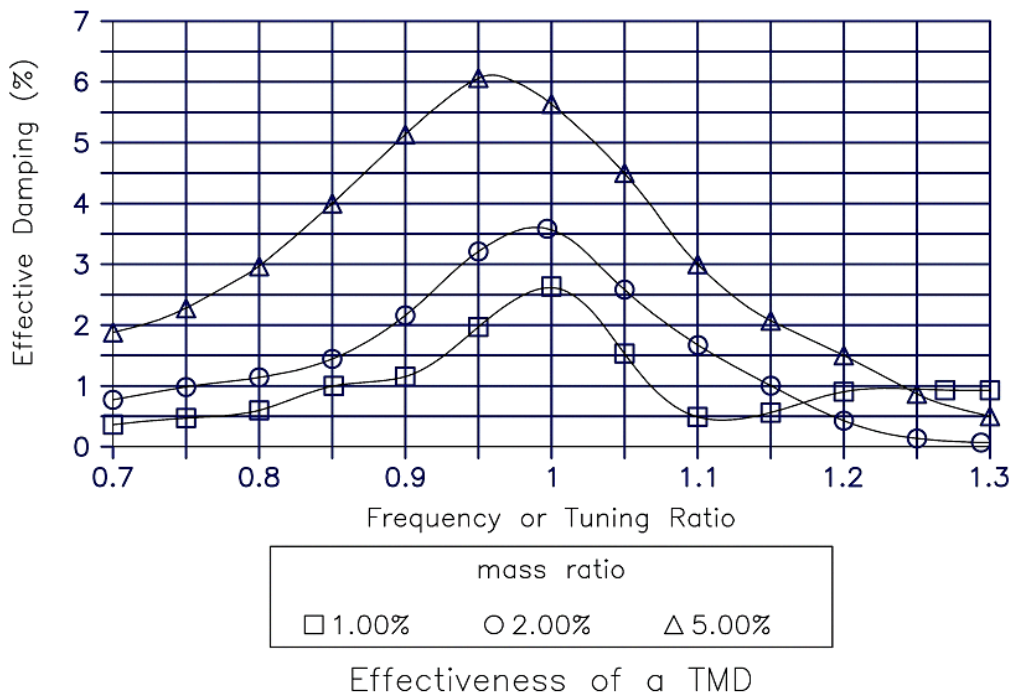

FIGURE 4 – EFFECTIVENESS OF A TMD

It should be noted that these expressions and relationships are for a linear system only. In reality, structures are rarely linear and it may also be advantageous to use non-linear characteristics of certain components in designing for more severe wind events. This is the case for the viscous damping devices used for the TMD damping on the Park Tower, where the higher forces produced by the non-linear viscous damping devices beneficially reduce the peak TMD displacements under the most severe wind events.

Figure 5 depicts the final configuration of the TMD that was designed by RWDI. Construction of the TMD in the upper mechanical levels of the Park Tower has been recently completed. The original illustration in color, highlights a number of the components. The main support cables are paired at each corner of the rectangular mass block. The structural steel above the mass block (blue and red in the color image), near the top of the image, is the tuning frame that can be lifted or lowered as required to tune the TMD to the frequency of the building. The red “frames” depicted in the foreground of the image are a mechanism called an “anti-yaw” mechanism. This device prevents the TMD mass from rotating (or yawing) as it swings from side to side. Two viscous dampers are also connected to the anti-yaw mechanism that will be used as a brake if it becomes necessary to stop the motion of the TMD. The angled cylindrical devices that slope from the mass to the floor are the viscous dampers specified by RWDI and supplied by Taylor Devices.

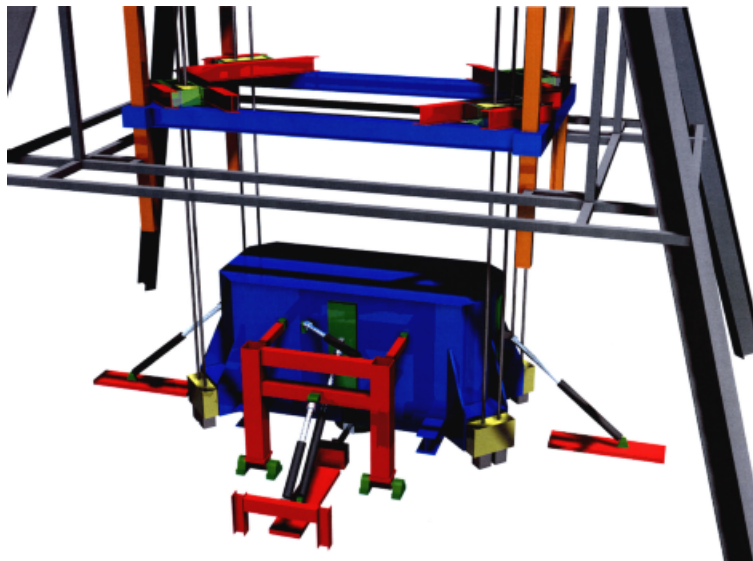

FIGURE 5 – THE TUNED MASS DAMPER SYSTEM

HYDRAULIC DAMPER DESIGN

Critical components of the TMD are the dampers themselves. Several types of dampers have been considered for use in TMD's. However, many of these types of dampers are not compatible with TMD's for tall buildings because they are unable to meet all the stringent requirements necessary for use in these applications. Typical requirements for the dampers include the following:

1. The damper(s) must obey the proper damping law (as a function of velocity, position, or both) over the appropriate environmental extremes in order to provide the proper level of added damping to the structure without shifting the ratio of natural frequency of the tuned mass to the natural frequency of the building itself. Recall that optimal TMD designs require a frequency ratio of 1:1 for periodic inputs. Typical TMD's of large structures can increase the total level of damping from 1 or 2% to 3-6% of critical damping, depending on the mass ratio as illustrated in Figure 4.

2. System friction must be mitigated in order to maintain a functional TMD regardless of the level of excitation to the structure. The presence of friction results in an inoperative TMD at lower levels and it introduces an unpredictable, inconsistent, and non-linear level of damping of the structure. Furthermore, friction always results in added wear to the components of the TMD that may drastically limit the life of these components.
3. The damper(s) must be of a maintenance free design for several reasons:

First and foremost, modern day tall buildings have a design life in the range of 50-100 years. Therefore, the TMD must also be designed for a long design life. Since TMD's operate at even small levels of excitation, the dampers must be designed to be in continuous motion for their entire life. (For the subject of this paper, the damper was required to operate for more than 300 million cycles.) This requires that each component of the damper be properly analyzed for fatigue resistance and stress levels must be held below the endurance limit to guarantee an infinite life.

Secondly, it is generally unacceptable to shut down operation of the TMD for an extended period of time for maintenance. Since maintenance of TMD's will typically take a period of at least several days, the peak accelerations may exceed acceptable levels during this time. Additionally, the cost of this maintenance is not insignificant and would have to be incurred at the time that maintenance is necessary.

4. Due to the high levels of building excitation during wind storms, the damper must be able to absorb a relatively high level of energy in a given amount of time (power) over the duration of the storm. All dampers convert input energy into another form, typically heat energy, and therefore must be designed to channel this energy through heat to its surroundings. Otherwise, a thermal runaway within the damper would cause the TMD to become completely inoperative. This high level of power input usually results in high operating temperatures and thus, the damper components must be able to withstand these unusually high temperatures.
5. The damper(s) must be able to operate during extreme conditions. For the extreme event, such as the 500 year design storm, the damper will need to self adjust without relying on an external driving actuator, thereby effectively increasing the level of damping in order to limit the motions of the mass during the event. This can be incorporated directly within the damping components of the TMD in the form of added damping (i.e. snubbing) at position or velocity extremes.

A damper design (patent pending) is presented here that addresses each of the aforementioned requirements. The heritage of this damper technology dates back to classified military and aerospace projects of the last 2 decades. It has also been approved and used by the U.S. Space Program for use on satellite deployment systems and the Space Shuttle. The design is illustrated in Figure 6.

The main components of the damper include a main pressure cylinder or shock tube, a second outer cylinder mounted in a concentric fashion to the pressure cylinder, an accumulator, a metal bellows main rod seal, a piston rod, a roller bearing assembly and an external sleeve. The chamber between each cylinder forms a crossover port to allow fluid to circulate between the metal bellows main rod seal and the accumulator. The crossover port also allows for equal distribution of heating on the external surfaces of the outer cylinder. This is necessary in order for the damper to be able to efficiently dissipate the high levels of heat typical in this type of application. The accumulator provides the ability of the fluid chamber to react to volume changes caused by piston rod displacement and thermal variations caused by either external heating or by internal heat generation. The metal bellows main rod seal is comprised of a series of thin washers or convolutions that are welded together to form an accordion-like assembly. The metal bellows forms a completely hermetic and frictionless seal. Additionally, since the stresses of the convolutions can be held below the endurance limit of the material, the seal is guaranteed for the life of the building.

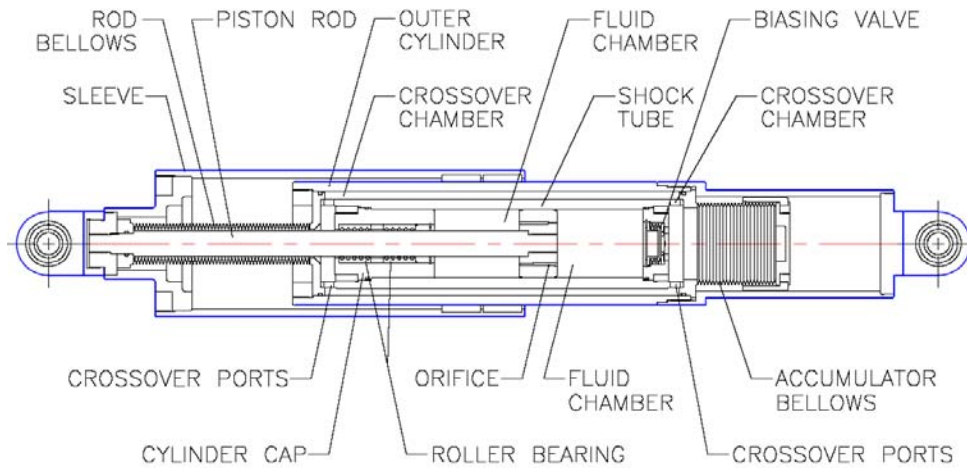

FIGURE 6 – MAINTENANCE FREE LOW FRICTION HYDRAULIC DAMPER (PATENT PENDING)

HYDRAULIC DAMPER COMPONENT LEVEL TESTING

In order to guarantee proper performance of the entire TMD, it is necessary to perform component level tests on the dampers themselves. Adjustments may be made after installation of the TMD into the structure to the frequency of the tuned mass and the damper output function individually. However, component level tests will verify important damper parameters such as nominal output function, deflection (stroke) capability, friction, power dissipation capability and snubbing action as previously outlined.

The damper under test is mounted to a load frame and a horizontal hydraulic actuator and is controlled by a computer and servo-valve system. This arrangement is illustrated in Figure 7.

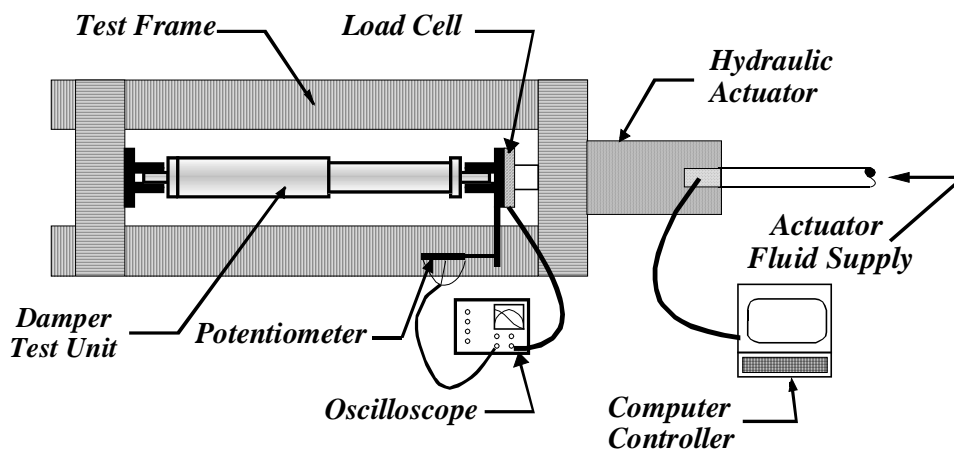

FIGURE 7 – DAMPER TEST ARRANGEMENT

The significance of testing the damper in a computer controlled servo-valve system is that actual input conditions can be accurately simulated and damper performance can be recorded for many different levels of building excitation. This is especially important when attempting to qualify the horsepower capability of the damper. Because wind storms do not result in constant and continuous levels of excitation, it is oftentimes difficult to analytically derive the upper working temperatures at which the damper will need to operate. Additionally, the ability of the damper to respond to various superimposed modes of excitation can be verified. Unlike typical vibration isolators, it is not desirable for the damper output to roll-off at higher frequencies.

In order to qualify the power dissipating capability of the damper, an input file was programmed into the test machine that represented the maximum expected power level. The temperature of the damper was then recorded after a condition of steady state heat transfer was achieved. In this case, the damper was expected to be capable of dissipating almost 2 horsepower with no external means of cooling allowable. Since the design of the damper accommodates a higher working temperature than conventional dampers, the power input level proved to be well within the capability of the damper. As previously mentioned, the damper design involves a crossover port that ensures equal distribution of heating on the external surfaces of the damper. During power verification testing, the damper exhibited a very consistent and well balanced temperature rise along its entire length, thereby efficiently dissipating the heat to the surrounding environment.

For the purposes of this project, damper output force varies with velocity squared. Although not always necessary, a damper that obeys this relationship has the advantage of being able to react to high input levels. During rare storms when the velocity of the tuned mass is high, the dampers absorb much more energy and can therefore prevent excessive motion of the tuned mass. Although somewhat easier to model, linear systems do not have this advantage and may therefore need to compensate for extreme input levels in some other fashion.

Figure 8 is an output curve that represents the allowable upper and lower force versus velocity curves of one type of damper for this project along with actual measured force values at discrete velocity points. The measured output closely follows a velocity squared relationship. These values were tested throughout a range of input frequencies and damper output proved to be insensitive to varying frequencies.

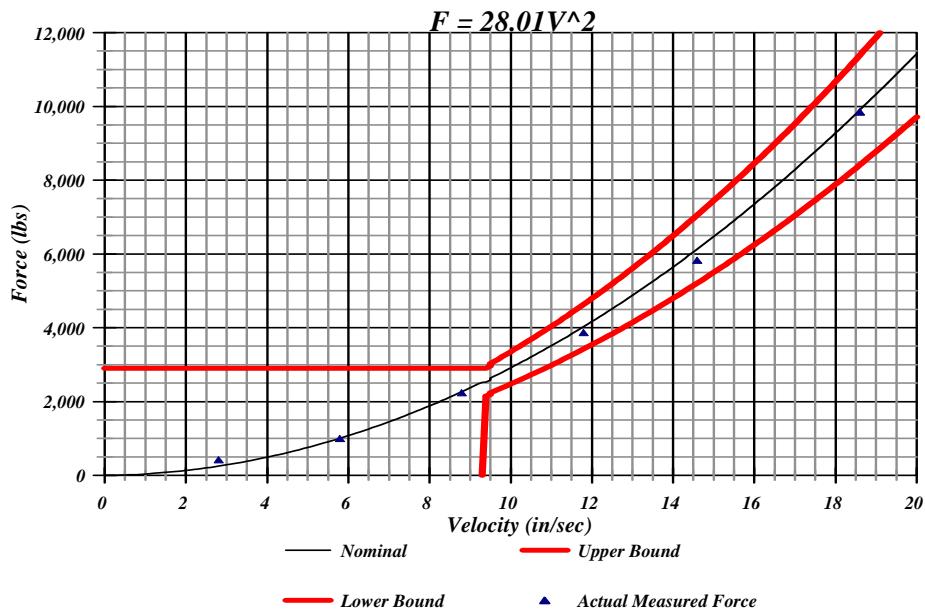

FIGURE 8 – DAMPER OUTPUT CURVE

PRIMARY SUPPORT CABLES

Another critical component of the TMD is the set of eight support cables. These cables not only suspend the 300 ton mass block, but also are of an appropriate length to allow the mass to behave as a natural pendulum. Cables were selected over other possible vertical supports, as a rotational bearing need not be provided at either end of the support when using a cable. As the mass will swing from side to side, the cables will have to flex to allow this movement. RWDI designed special cable housings with appropriately machined surfaces for the cables to bend over as the mass swings to either side. These cable housings also ensured that the location where the bending stresses are induced into the cables differ from the end connection of the cable. Given the relatively large diameter of the support cables of 2.50 inches, spelter fittings were used for the end connections of the cables. In addition, an ultra-flexible cable design was used to assist with reducing bending stresses in the cables which could over the long term cause fatigue damage to the cables.

To verify the factors of safety for the design of the cables, a cable destruction test was performed on a ninth cable. This test demonstrated that the design factor of safety of 3 for each cable was exceeded by 40%. In reality the design factor of safety for the support system is closer to 6 as RWDI designed the cable support system in such a way that only 1 cable is required at each corner. This way, if one cable were to fail, there would be a “backup” cable. The 2.50 inch diameter cable failed under a load of over 623,000 lbs (300 tons). The results of the testing provided an excellent level of comfort for the cable system that supports the 300 ton mass block.

RESULTING IMPROVEMENT IN PEAK ACCELERATION

In order to quantify the overall improvement realized through the addition of the TMD, we can compare the peak acceleration of the top occupied condominium of the building with respect to the return period both with and without the TMD. This comparison is illustrated in Figure 9. Notice that the reduction in acceleration is significant. In fact, recall that the criteria suggested by The International Organization for Standardization (ISO) over a 5 year return period is approximately 18 milli-g's. The addition of the TMD resulted in a peak acceleration of less than 15 milli-g's over a 10 year return period.

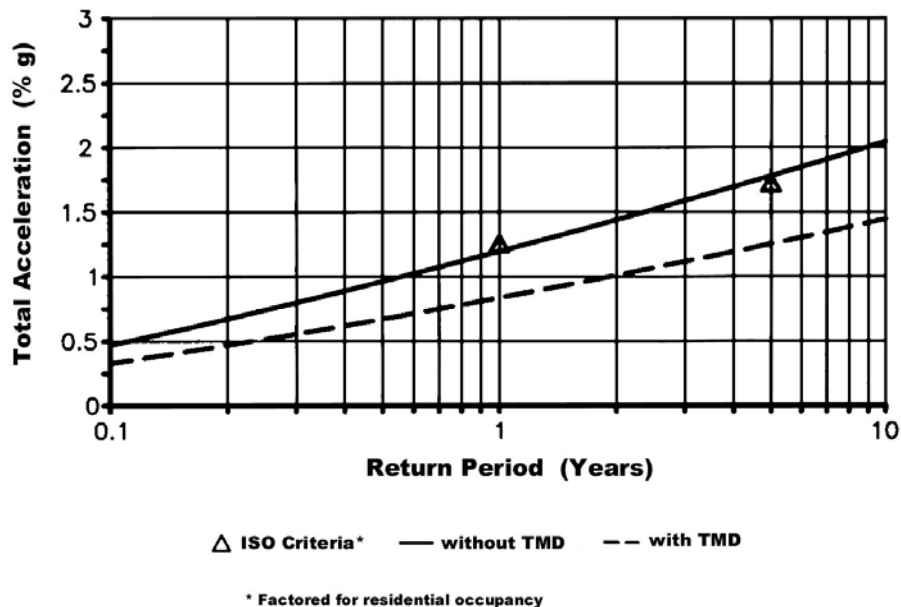

FIGURE 9 – ACCELERATION WITH AND WITHOUT TMD

CONCLUSIONS

Analytical test results, component level tests, and preliminary system level measurements have demonstrated the effectiveness of using a passive tuned mass damper system with hermetically sealed, frictionless hydraulic dampers to effectively increase the level of damping in a high rise building to desired levels. This increased level of damping has been shown to reduce undesirable accelerations in the building in order to guarantee occupant comfort in an otherwise uncomfortable environment.

The Park Tower TMD will be commissioned in late 2000 and testing will be performed to verify the performance of the TMD. Extensive wind tunnel testing and subsequent analytical modeling, combined with component level testing were used to ensure that the TMD will operate as designed. Critical components, such as the hydraulic dampers and the support cables were designed and tested to ensure many years of safe operation of the TMD.

The project outlined here has verified the following:

1. An analytical model coupled with wind tunnel tests can derive an accurate prediction of the peak acceleration of a high rise building subject to wind induced oscillations.
2. A relatively simple and robust tuned mass damper system can be designed to reduce these peak accelerations to provide an acceptable occupant comfort level according to published guidelines.
3. Passive TMD's with no requirement for an external power source can be as effective as other systems but do not carry the disadvantages of these types of systems which include high implementation costs, maintenance costs, system complexities and the need for a continuous and non-interrupted power supply.
4. A TMD system can be provided that is completely maintenance free (other than routine inspection) and reliable for the life of the building. This system includes an ultra-flexible cable design and hermetically sealed, frictionless hydraulic dampers which use existing technology previously used and qualified by the U.S. Military, NASA, the medical industry, and now the structural engineering community.

REFERENCES

- [1] Den Hartog, J.P., 1956, *Mechanical Vibrations*, 4th Edition, McGraw-Hill, New York.

BIBLIOGRAPHY

Breukelman, B., "Tuned Mass Dampers - How They Work," Technotes Issue #6, RWDI Newsletter Article, Guelph, Ontario, Canada.

Inman, D.J., 1989, *Vibration with Control, Measurement, and Stability*, Prentice Hall, Englewood Cliffs, NJ.

Irwin, P.A., "Motion Criteria," Newsletter Article, Technotes Issue #2, RWDI, Guelph, Ontario, Canada.

Sadek, F., Mohraz, B., Taylor, A.W. and Chung, R.M., "A Method of Estimating the Parameters of Tuned Mass Dampers for Seismic Applications," *Earthquake Engineering and Structural Dynamics*, 1997, Vol. 26, 617-635.

Simiu, E. and Scanlon, R.H., 1986, *Wind Effects on Structures*, 2nd Edition, John Wiley & Sons, Inc., New York, NY.

Thomson, W.T., 1998, *Theory of Vibration with Applications*, Prentice Hall, Englewood Cliffs, NJ, 3rd Edition.

ACKNOWLEDGMENTS

The authors would like to acknowledge Mrs. Lorrie Battaglia of Taylor Devices, Inc. for her assistance with this paper. Her patience and expertise is greatly appreciated